

version .0

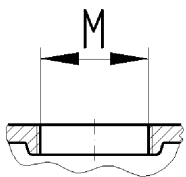

version .1

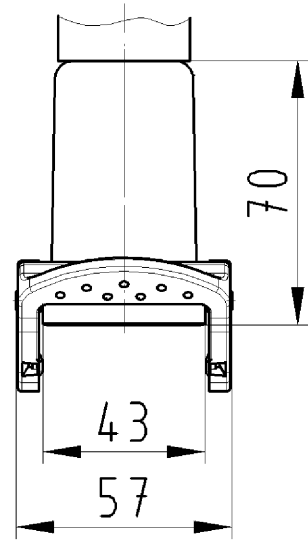
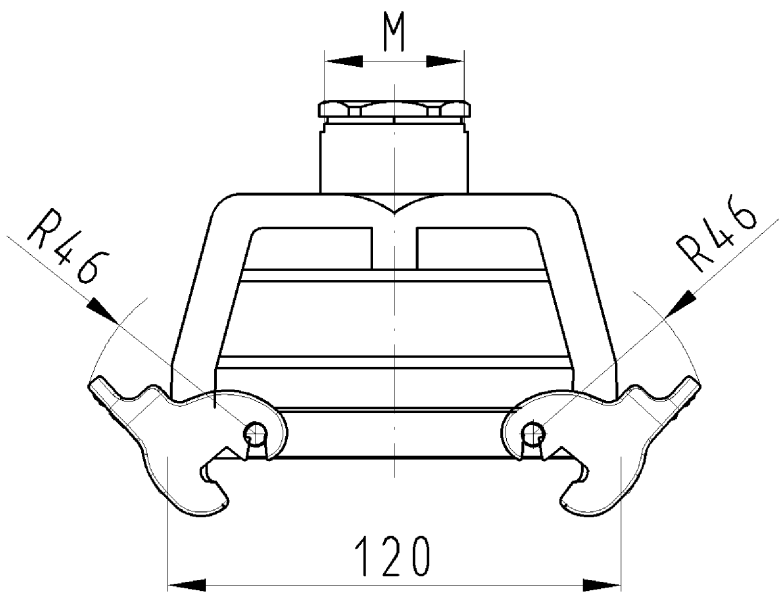
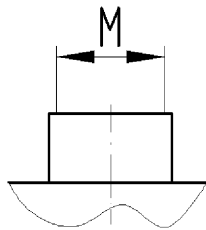

version .2

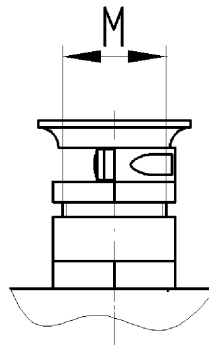

version .3

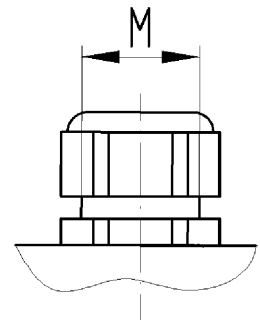

version .5

IP 65

Gehäuseoberteil  
70.357.2435.0

Zeichnungsnummer  
70.357.2435.010W  
Gehäuseoberteil

03.12.2007  
Hoffmann Angelika  
M 1:2